

# CCS Technical Documentation

## NHL-2NA Series Transceivers

# Quick Guide

[This page left intentionally blank]

## Table of Contents

	<b>Page No</b>
Install the SIM card .....	4
Install the battery .....	5
Switching the phone on/off .....	5
Normal position .....	5
Tips on efficient operation .....	5
Joystick .....	5
Making a call .....	6
Taking a picture .....	6
Keyguard .....	6
NHL-2NA Shortcuts .....	7
Shortcuts in Standby mode .....	7
Shortcuts in editors .....	7
Other shortcuts .....	7
NHL-2NA Keys and parts .....	8

## Install the SIM card

Keep all miniature SIM cards out of the reach of small children.

Before removing the cover(s), always switch off the power and disconnect the phone from the charger or any other device. Always store and use the phone with the covers attached.

Open the sliding cover: take hold of the back part of the phone and push the phone to open the sliding cover.

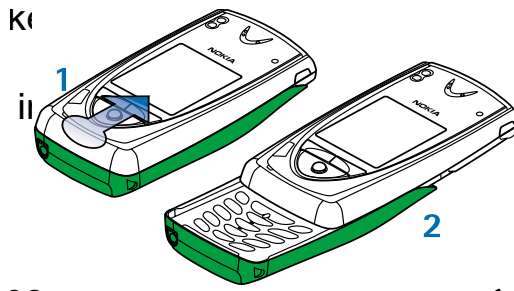

Open the A-cover: with the back of the phone facing you, put your thumb in the middle of the cover, slide it forward and then lift it.

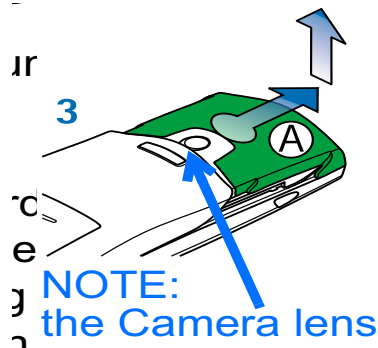

Put the SIM card into the slot, golden contacts down and bevelled corner out ward from the slot.

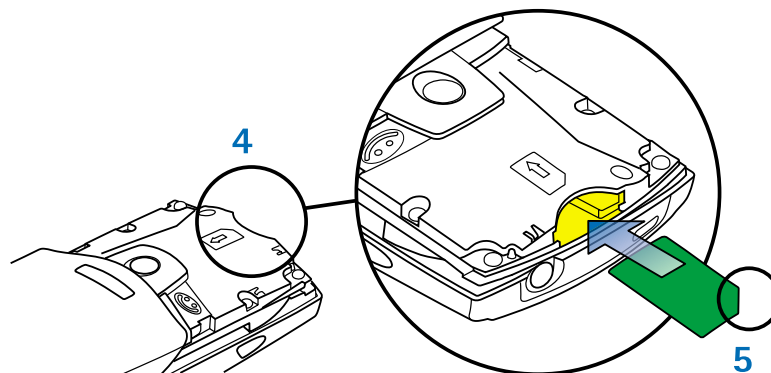

Replace the A cover: insert the two catches on the sides of the cover into the corresponding slots in the phone and slide the cover until it locks in place.

## Install the battery

Open the B cover: press the locking catch and at the same time slide the cover.

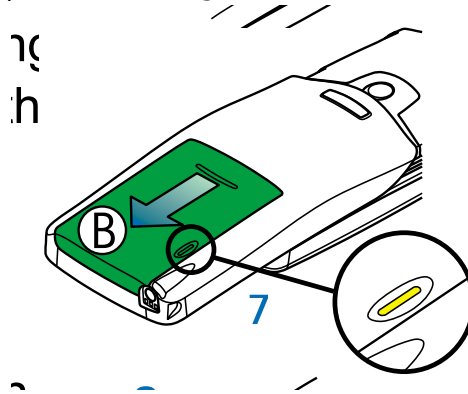

Install the battery: align the contacts with the corresponding connectors of the phone and push the opposite end of the battery until it snaps in place.

Replace the B cover by sliding it back into place.

Charge the battery, the charging contact is at the lower left hand corner of the phone.

## Switching the phone on/off

**WARNING!** Do not switch on the phone when wireless phone use is prohibited or when it may cause interference or danger.

Press and hold the power key at the top right of the phone.

Key in the first settings (time, date) with the number keys and press OK soft key to accept.

## Normal position

Hold the phone as you would any other telephone with the antenna pointed up and over your shoulder.

## Tips on efficient operation

Your phone has a built-in antenna. As with any other radio transmitting device, do not touch the antenna unnecessarily when the phone is switched on. Contact with the antenna affects call quality and may cause the phone to operate at a higher power level than otherwise needed. Not touching the antenna area during a phone call optimises the antenna performance and the talktime of your phone.

## Joystick

To move the focus on the display, push the joystick to the left, right, up and down. Press the joystick to open an application, to take a picture, to make selections, changes or to confirm an operation.

## Making a call

Open the sliding cover. In standby mode key in the phone number including the area code.

Press green handset pic key to initiate the call

Press red handset pic key to end the call

Closing the sliding cover ends all voice calls and rejects an incoming call.

## Taking a picture

**IMPORTANT:** Make sure to obey all laws governing the taking of pictures. Do not use this feature illegally.

Open the sliding cover to open the camera lens and press soft key Camera in standby mode. The Camera application opens and you can see the view to be captured on the display of the phone.

Press the joystick to take a picture.

Press soft key Delete if you do not want to save the photo. Else the photos are saved automatically in the Images application.

To take another picture press the joystick to return to the viewfinder.

## Keyguard

To lock the keys close the sliding cover and press the soft key Keyguard. Key icon appears on display.

To unlock the keys open the sliding cover and press the soft key Unlock and then OK.







When the keyguard is on, to answer a call, press the green handset pic key. During a call the phone can be operated in the normal way. When you end or reject the call, the keypad will be automatically locked.

Note: When Keyguard is on, calls may be possible to the emergency number programmed into your phone (e.g. 112 or other official emergency number). Open the sliding keypad and key in the emergency number and press . The number is displayed only after you have keyed in its last digit.







For more information about using the phone kindly refer to the Nokia 7650 phone user's guide.

## NHL-2NA Shortcuts



### Shortcuts in Standby mode

- Press  (Menu key) to open the main Menu.
- Press the joystick to open Contacts.
- Press  to open a list of the last dialed numbers. Move the joystick to the left to view received and missed calls lists.
- To change the profile, press  (power key) briefly and select the profile.
- Press and hold  (voice key) to start voice dialling. See p.43 in the User's Guide.
- Press  and  to call your voice mailbox. See p. 17 in the User's Guide.

### Shortcuts in editors

- Press  (Edit key) to open a list of commands related to writing and editing text. Press  to switch between predictive, traditional text input and number mode (*Dictionary -> Dictionary on, Alpha mode, Number mode*)
- When you are writing, press  repeatedly to access different kinds of special characters, or press  to open a list of special characters. Press  to enter a space.
- You can also use  to mark items. Press and hold  and at the same time, move the joystick to mark text to be copied or erased.

### Other shortcuts

- When you have an active phone call, press  (voice key) briefly to change to loudspeaker mode. See p. 13 in the User's Guide.
- In the main Menu, press and hold  (Menu key) to open a view where you can see all the applications that are open and switch between them. See also p. 9 in the User's Guide.

## NHL-2NA Keys and parts

